

GIRANDOLA

di Enrica Dray

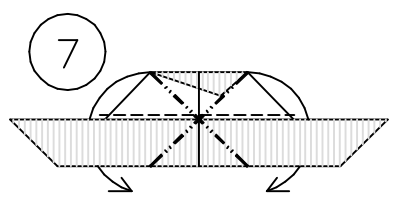

piegare come base quadrata

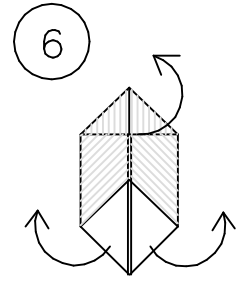
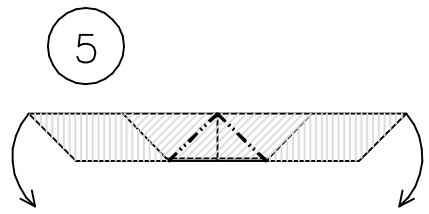
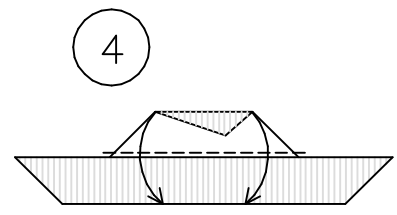
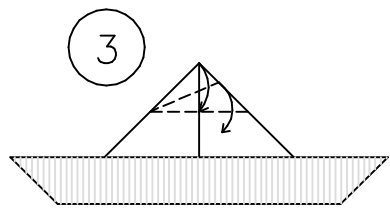
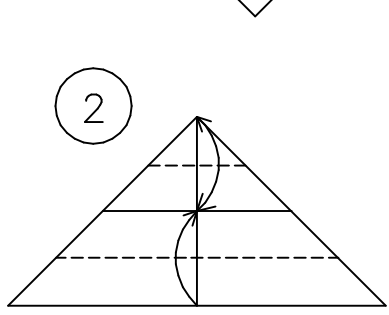
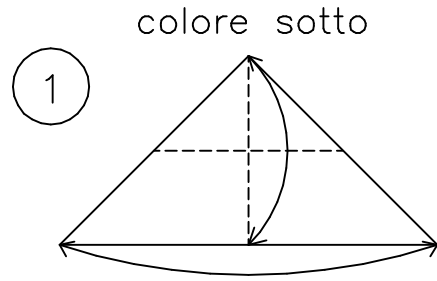
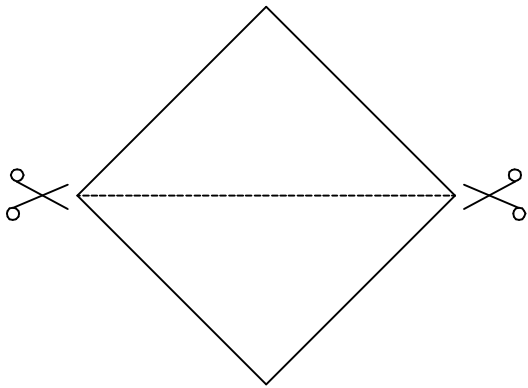
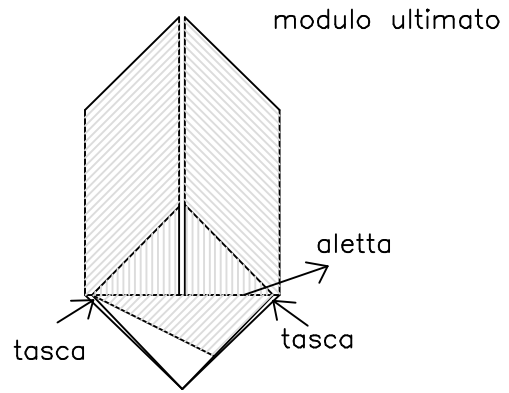

piegare 8 moduli

unione dei moduli

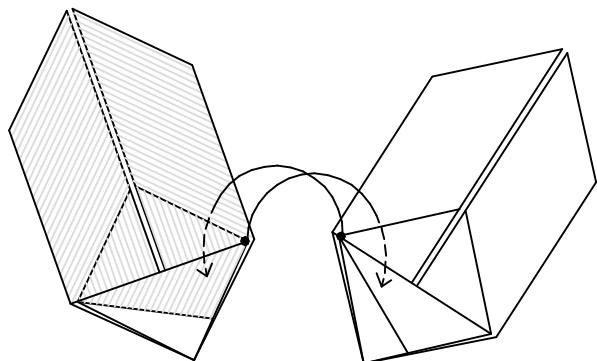

1

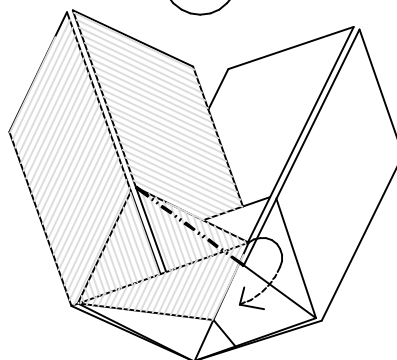

piegare e intascare

2

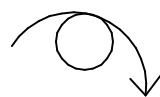
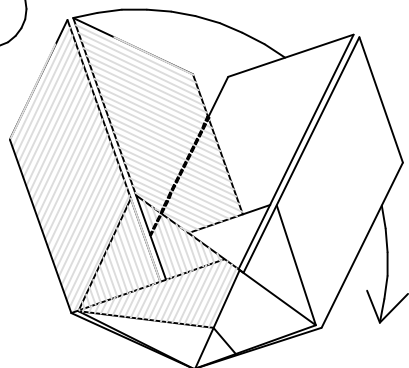

3

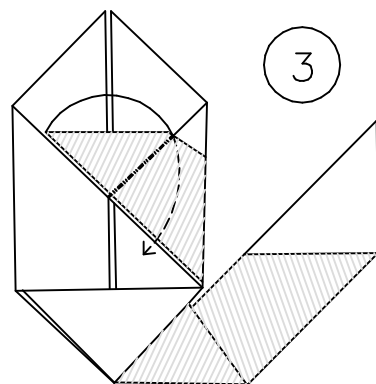

piegare e intascare

4

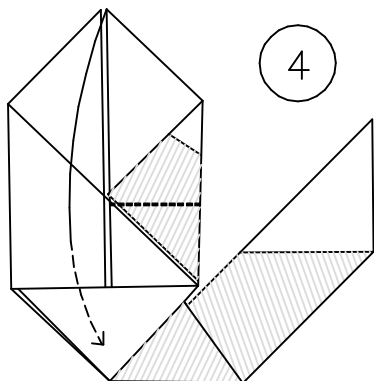

piegare e intascare

bloccaggio ultimato

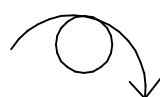
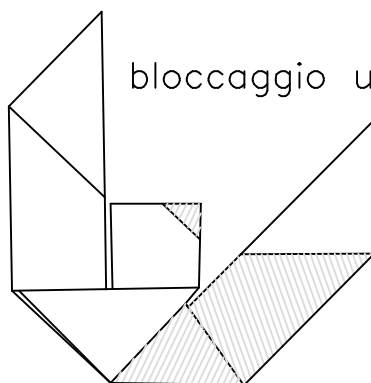

unire 8 moduli

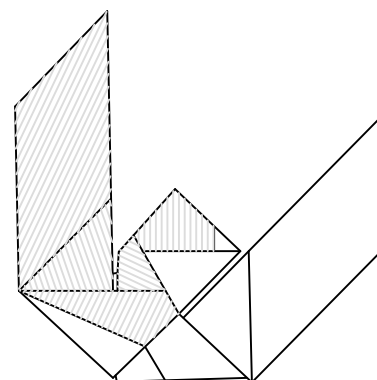

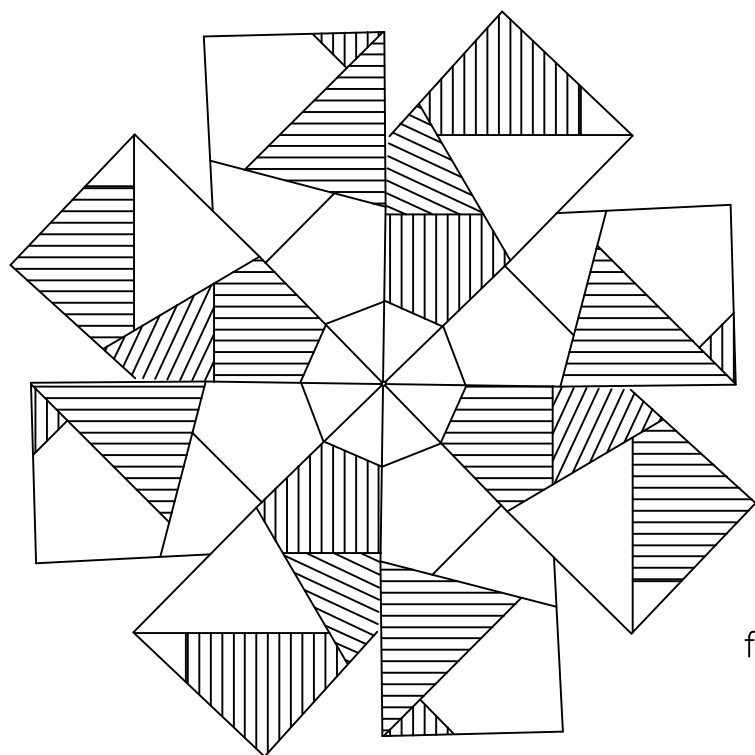

fronte

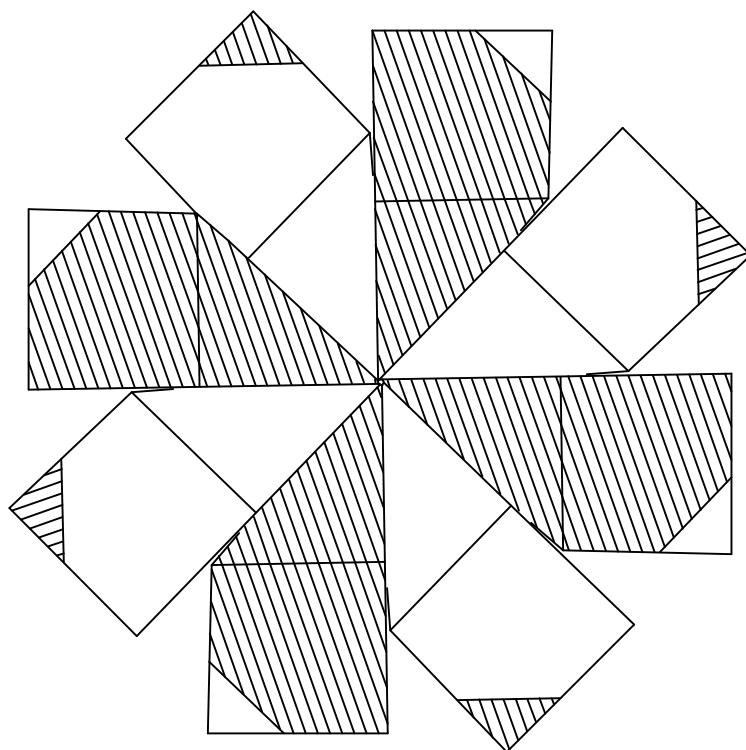

retro